

# Data Sheet

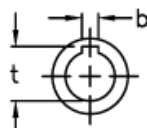

Article number: 2301077521  
Description: E+G Handwheel  
VR.180 FP+I

## Measures

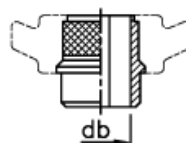
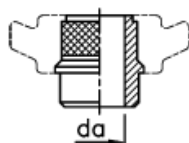
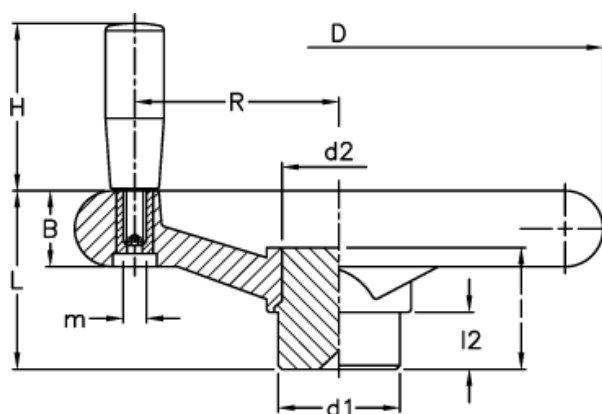

da max tilladelig boring uden not

db max tilladelig boring med not

b	= 6	H	= 80
B	= 24	l	= 43
C (N m)	= 280	L	= 56
D	= 180	L (J)	= 15
d1	= 40	l2	= 15
d2	= 31	m	= M10
da	= 26	R	= 68
db	= 22	t	= 24.8